

SIDE VIEW

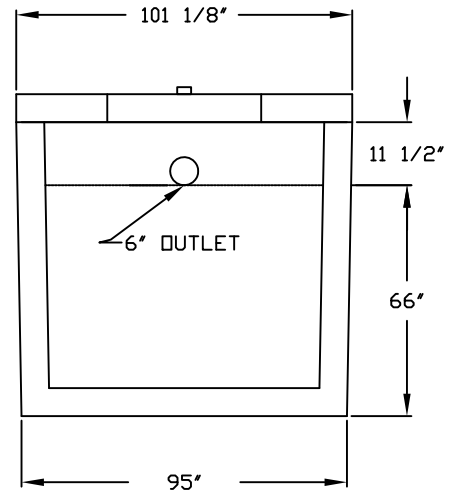

END VIEW

TANK: CATEGORY 3. 4" 4150 GALLON 1 COMPARTMENT TANK REINFORCED WITH #4 STEEL 12" O/C. BOTH WAYS. 4" WALLS AND 4" BOTTOM. INLET AND OUTLET RESILIENT CONNECTORS PER ASTM-923-98. CONNECTORS MUST BE USED WITH APPROVED CLAMP. CONNECTOR WILL ACCEPT 6" PVC PIPE.

LIDS: 5" LID WITH 1-22" ROUND MANHOLE COVER AT EACH END OF TANK
 8" LID WITH 1-22" ROUND MANHOLE COVER AT EACH END OF TANK
 BOTH LIDS ARE REINFORCED WITH GRADE 60 REBAR.

TANK & LIDS: 4000 PSI CONCRETE AT 28 DAYS

IMPRINTED ON INLET END OF TANK:

LEGEND: FSI4150 STATE APPROVAL: 01-011-70P-C3

WEIGHTS: TANK ONLY 19,230
 TANK W/ 5" LID 26,620
 TANK W/ 8" LID 31,050

THIS SEWAGE TREATMENT RECEPTACLE HAS BEEN DESIGNED, CONSTRUCTED AND STRUCTURALLY TESTED IN ACCORDANCE WITH CHAPTER 64E-6.013, FLORIDA ADMINISTRATIVE CODE, (FAC) DATED APRIL 28, 2010.

DRAWING NOT TO SCALE

FLORIDA SEPTIC, INC.
 P.O. BOX 545
 HAWTHORNE, FLORIDA 32640
 (800) 940-8265

MODEL:
 4" 4150 GAL. TANK

REVISED:
 05/01/2011

APPROVAL DATE:
 02/14/2008