

SIDE VIEW

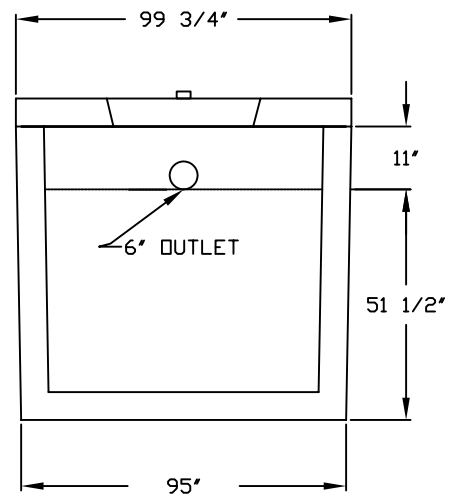

END VIEW

**TANK: CATEGORY 4. 4" 3100 GALLON 1 COMPARTMENT TANK REINFORCED WITH #3 STEEL 12" O/C. BOTH WAYS. 4" WALLS AND 4" BOTTOM. INLET AND OUTLET RESILIENT CONNECTORS PER ASTM-923-98. CONNECTORS MUST BE USED WITH APPROVED CLAMP. CONNECTOR WILL ACCEPT 6" PVC PIPE.**

**LIDS: 5" LID WITH 1-22" ROUND MANHOLE COVER AT EACH END OF TANK  
8" LID WITH 1-22" ROUND MANHOLE COVER AT EACH END OF TANK  
BOTH LIDS ARE REINFORCED WITH GRADE 60 REBAR.**

**TANK & LIDS: 4000 PSI CONCRETE AT 28 DAYS**

**IMPRINTED ON INLET END OF TANK:**

**LEGEND: FSI3100 STATE APPROVAL: 01-011-62S-C4**

**WEIGHTS: TANK ONLY 16,480  
TANK W/ 5" LID 23,870  
TANK W/ 8" LID 28,300**

**THIS SEWAGE TREATMENT RECEPTACLE HAS BEEN DESIGNED, CONSTRUCTED AND STRUCTURALLY TESTED IN ACCORDANCE WITH CHAPTER 64E-6.013, FLORIDA ADMINISTRATIVE CODE, (FAC) DATED MARCH 22, 2000.**

**DRAWING NOT TO SCALE**

**FLORIDA SEPTIC, INC.**  
P.O. BOX 545  
HAWTHORNE, FLORIDA 32640  
(800) 940-8265

**MODEL:**  
4" 3100 GAL. TANK

**REVISED:**  
02/15/2008

**APPROVAL DATE:**  
02/14/2008