

SIDE VIEW

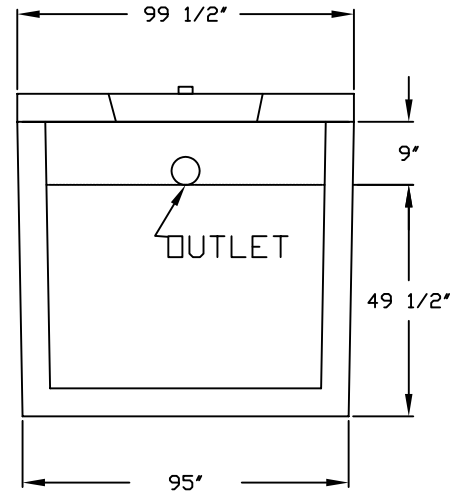

END VIEW

TANK: CATEGORY 4. 4" 3000 GALLON 1 COMPARTMENT TANK REINFORCED WITH #3 STEEL 12" O/C. BOTH WAYS. 4" WALLS AND 4" BOTTOM. INLET AND OUTLET RESILIENT CONNECTORS PER ASTM-923-98. CONNECTORS MUST BE USED WITH APPROVED CLAMP. CONNECTOR WILL ACCEPT 4" PVC PIPE.

LIDS: 5" LID WITH 1-22" ROUND MANHOLE COVER AT EACH END OF TANK
 8" LID WITH 1-22" ROUND MANHOLE COVER AT EACH END OF TANK
 BOTH LIDS ARE REINFORCED WITH GRADE 60 REBAR.

TANK & LIDS: 4000 PSI CONCRETE AT 28 DAYS

IMPRINTED ON INLET END OF TANK:

LEGEND: FSI3000 STATE APPROVAL: 01-011-56S-C4

WEIGHTS: TANK ONLY 15,980
 TANK W/ 5" LID 23,370
 TANK W/ 8" LID 27,800

THIS SEWAGE TREATMENT RECEPTACLE HAS BEEN DESIGNED, CONSTRUCTED AND STRUCTURALLY TESTED IN ACCORDANCE WITH CHAPTER 64E-6.013, FLORIDA ADMINISTRATIVE CODE, (FAC) DATED MARCH 22, 2000.

DRAWING NOT TO SCALE

FLORIDA SEPTIC, INC.
 P.O. BOX 545
 HAWTHORNE, FLORIDA 32640
 (800) 940-8265

MODEL:
 4" 3000 GAL. TANK

REVISED:
 02/15/2008

APPROVAL DATE:
 08/14/2001