

SIDE VIEW

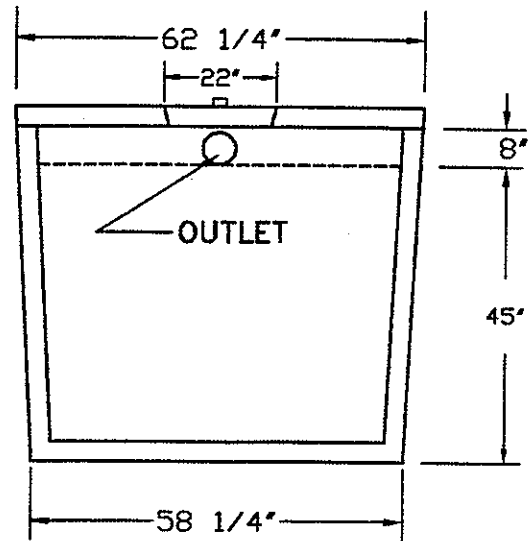

END VIEW

TANK: CATEGORY 4. 3" 525 GALLON 1 COMPARTMENT TANK REINFORCED WITH FIBRILLATED POLYPROPYLENE FIBER. 3" WALLS AND 3" BOTTOM. INLET AND OUTLET RESILIENT CONNECTORS PER ASTM-923-98. CONNECTORS MUST BE USED WITH APPROVED CLAMP. CONNECTOR WILL ACCEPT 4" PVC PIPE.

**LIDS: 3" LID WITH 1-22" ROUND MANHOLE COVER
8" LID WITH 1-22" ROUND MANHOLE COVER
LID IS REINFORCED WITH GRADE 60 REBAR.**

TANK & LID: 4000 PSI CONCRETE AT 28 DAYS

IMPRINTED ON INLET END OF TANK:

LEGEND: FSI 525 STATE APPROVAL NUMBER: 01-011-97S-C4

**WEIGHTS: TANK ONLY 3,460
TANK & 3" LID 4,380
TANK & 8" LID 5,972**

THIS SEWAGE TREATMENT RECEPTACLE HAS BEEN DESIGNED, CONSTRUCTED AND STRUCTRALLY TESTED IN ACCORDANCE WITH CHAPTER 64E-6.013, FLORIDA ADMINISTRATIVE CODE, (FAC) DATED MARCH 22, 2000

DRAWING NOT TO SCALE

FLORIDA SEPTIC, INC.

P.O. BOX 545

HAWTHORNE, FLORIDA 32640

1-800-940-8265

MODEL:

3"-525 GAL. TANK

REVISED:

12/27/01

APPROVAL DATE:

02/02/01