

**SIDE VIEW**

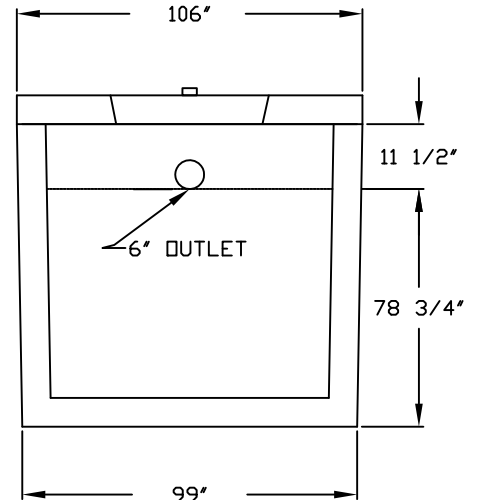

**END VIEW**

**TANK: CATEGORY 4. 6" 4900 GALLON 1 COMPARTMENT TANK REINFORCED WITH #4 STEEL 12" O/C. BOTH WAYS. 6" WALLS AND 6" BOTTOM. INLET AND OUTLET RESILIENT CONNECTORS PER ASTM-923-98. CONNECTORS MUST BE USED WITH APPROVED CLAMP. CONNECTOR WILL ACCEPT 6" PVC PIPE.**

**LIDS: 5" LID WITH 1-22" ROUND MANHOLE COVER AT EACH END OF TANK  
8" LID WITH 1-22" ROUND MANHOLE COVER AT EACH END OF TANK  
BOTH LIDS ARE REINFORCED WITH GRADE 60 REBAR.**

**TANK & LIDS: 4000 PSI CONCRETE AT 28 DAYS**

**IMPRINTED ON INLET END OF TANK:**

**LEGEND: FSI4900 STATE APPROVAL: 01-011-74P-C4**

**WEIGHTS: TANK ONLY 32,415  
TANK W/ 5" LID 40,778  
TANK W/ 8" LID 45,795**

**THIS TANK IS RATED FOR H-20 LOADING WHEN USED WITH 8" TRAFFIC LID AND TANK BURIAL DEPTH IS AT LEAST 18" BELOW GROUND SURFACE.**

**THIS TANK COMPLIES WITH SECTION 1003.5 OF THE 2007 FLORIDA PLUMBING CODE.**

**INTERCEPTOR CAPACITY PER 1003.5.1 IS SITE SPECIFIC.**

**THIS SEWAGE TREATMENT RECEPTACLE HAS BEEN DESIGNED, CONSTRUCTED AND STRUCTURALLY TESTED IN ACCORDANCE WITH CHAPTER 64E-6.013, FLORIDA ADMINISTRATIVE CODE, (FAC) DATED APRIL 28, 2010.**

**DRAWING NOT TO SCALE**

**FLORIDA SEPTIC, INC.**  
P.O. BOX 545  
HAWTHORNE, FLORIDA 32640  
(800) 940-8265

**MODEL:**  
6" 4900 GAL. TANK

**REVISED:**  
05/01/2011

**APPROVAL DATE:**  
02/28/2011