

SIDE VIEW

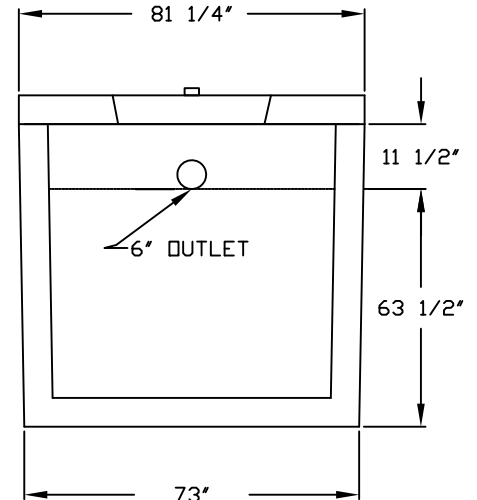

END VIEW

TANK: CATEGORY 4. 6" 2180 GALLON 1 COMPARTMENT TANK REINFORCED WITH #4 STEEL 12" O/C. BOTH WAYS. 6" WALLS AND 6" BOTTOM. INLET AND OUTLET RESILIENT CONNECTORS PER ASTM-923-98. CONNECTORS MUST BE USED WITH APPROVED CLAMP. CONNECTOR WILL ACCEPT 6" PVC PIPE.

**LIDS: 5" LID WITH 1-22" ROUND MANHOLE COVER AT EACH END OF TANK
8" LID WITH 1-22" ROUND MANHOLE COVER AT EACH END OF TANK
BOTH LIDS ARE REINFORCED WITH GRADE 60 REBAR.**

TANK & LIDS: 4000 PSI CONCRETE AT 28 DAYS

IMPRINTED ON INLET END OF TANK:

LEGEND: FSI2180 STATE APPROVAL: 01-011-45P-C4

**WEIGHTS: TANK ONLY 20,169
TANK W/ 5" LID 24,381
TANK W/ 8" LID 28,593**

THIS TANK IS RATED FOR H-20 LOADING WHEN USED WITH 8" TRAFFIC LID AND TANK BURIAL DEPTH IS AT LEAST 18" BELOW GROUND SURFACE.

THIS TANK COMPLIES WITH SECTION 1003.5 OF THE 2007 FLORIDA PLUMBING CODE.

INTERCEPTOR CAPACITY PER 1003.5.1 IS SITE SPECIFIC.

THIS SEWAGE TREATMENT RECEPTACLE HAS BEEN DESIGNED, CONSTRUCTED AND STRUCTURALLY TESTED IN ACCORDANCE WITH CHAPTER 64E-6.013, FLORIDA ADMINISTRATIVE CODE, (FAC) DATED APRIL 28, 2011.

DRAWING NOT TO SCALE

FLORIDA SEPTIC, INC.
P.O. BOX 545
HAWTHORNE, FLORIDA 32640
(800) 940-8265

MODEL:
6" 2180 GAL. TANK

REVISED:
05/01/2011

APPROVAL DATE:
02/28/2011